

Set contents

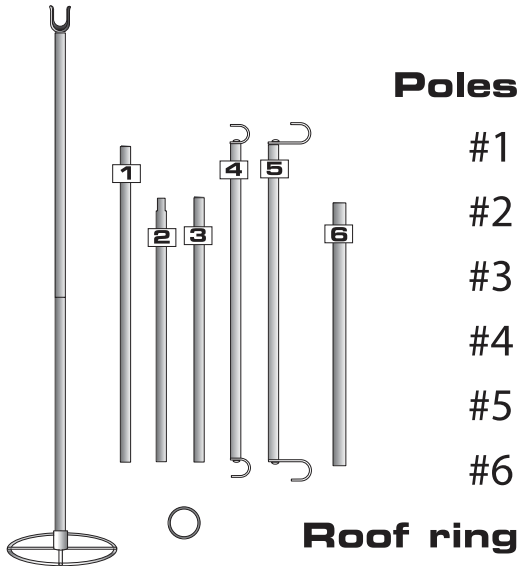



Poles

- #1
- #2
- #3
- #4
- #5
- #6



Roof ring

Roof support column





Connectors

-  3 way (corner)
-  4 way (side)
-  5 way inside corner

Panels

-  Plain
-  Entrance
-  Ventilation

other

-  Floor basin
-  Roof top
-  Velcro basin connector
-  Straps

	Set 1	Set 2	Set 3
#1	8	6	1
#2	4	2	0
#3	4	2	0
#4	1	1	1
#5	1	1	1
#6	0	0	2
Roof ring	0	0	1
Roof support column			1
3 way (corner)	8	1	0
4 way (side)	0	4	0
5 way inside corner	2	0	0
Plain	0	1	0
Entrance	1	1	0
Ventilation	3	0	0
Floor basin	1	1	1
Roof top	1	1	1
Velcro basin connector	0	1	2
Straps	4		